

Proportional pressure reducing valve, pilot-operated

Type HD-3DRE(M) and 3DRE(M)E-7X



- ▶ Sizes 10 and 16
- ▶ Component series 7X
- ▶ Maximum set pressure 315 bar
- ▶ Maximum flow 300 l/min

Features

- ▶ 3-way version
- ▶ Operation by means of proportional solenoid with rotatable coil
- ▶ For subplate mounting
- ▶ Porting pattern according to ISO 4401
- ▶ Maximum pressure limitation, optional
- ▶ Valve and control electronics from a single source ▶ Integrated electronics (OBE) (type HD-3DRE(M)E):
 - Little manufacturing tolerance of the command value pressure characteristic curve
- ▶ External control electronics (type HD-3DRE(M))
- ▶ Linear command value pressure characteristic curve

Contents

Features	1
Ordering code	2
Symbols	3
Function, section	4, 5
Pilot oil supply	5
Technical data	6, 7
Electrical connections and assignment	8
Block diagram	9
Characteristic curves	10 ... 14
Dimensions	15 ... 17
Accessories	18
Further information	18

Ordering code

01	02	03	04	05	06	07	08	09	10	11	12	13	14	15
HD	-	3DRE			P	-	7X	/		G24				*

01	Huade hydraulic	HD
02	Proportional pressure reducing valve in 3-way version	3DRE
03	Without maximum pressure limitation	no code
	With maximum pressure limitation	M
04	For external control electronics	no code
	With integrated electronics (OBE)	E

Size

05	Size 10	10
	Size 16	16
06	Subplate mounting	P
07	Component series 70 ... 79 (70 ... 79: unchanged installation and mounting dimensions)	7X

Pressure rating

08	Up to 50 bar	50
	Up to 100 bar	100
	Up to 200 bar	200
	Up to 250 bar (only size 16)	250
	Up to 315 bar (only size 10)	315
09	Internal pilot oil supply, external pilot oil return	Y
	External pilot oil supply, external pilot oil return	XY

Supply voltage

10	24 VDC voltage	G24
----	----------------	-----

Coil

11	1600 mA	no code
	800 mA (only for external control electronics)	-8

Electrical connection

12	- Type 3DRE(M)	
	Without mating connector; connector DIN EN 175301-803	K4
	- Type DBE(M)E	
	Without mating connector; connector DIN EN 175201-804	K31

Interfaces of the control electronics

13	Command value input 0 ... 10 V	A1
	Command value input 4 ... 20 mA	F1
	External control electronics	no code

Seal material (observe compatibility of seals with hydraulic fluid used, see page 7)

14	FKM seals	V
	NBR seals	M
15	Further details in the plain text	

Symbols

"3DRE...Y..."

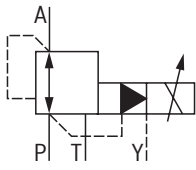

"3DREM...Y..."

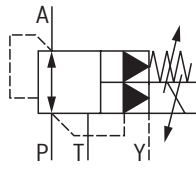

"3DRE...XY..."

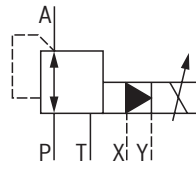

"3DREM...XY..."

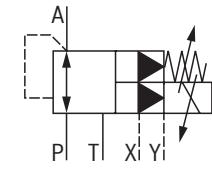

"3DREE...Y..."

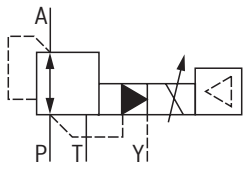

"3DREME...Y..."

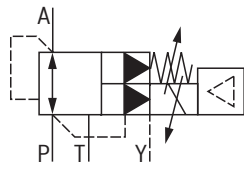

"3DREE...XY..."

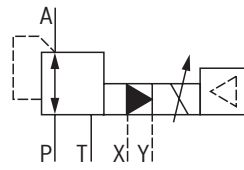

"3DREME...XY..."

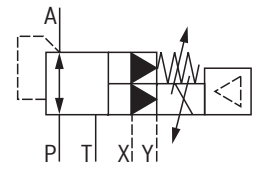

Function, section

The valve types 3DRE(M) and 3DRE(M)E are electrically pilot-operated 3-way pressure reducing valves with pressure limitation of the actuator. They are used for reduction (P to A) and limitation (A to T) of a system pressure.

Set-up

The valves consist of two main assemblies:

- ▶ Pilot control valve (1) with proportional solenoid (2), optionally with maximum pressure limitation (15)
- ▶ Main valve (3) with main control spool (4)

Function

- ▶ Command value-dependent setting of the pressure to be reduced in port A via the pilot control valve (1).
- ▶ With depressurized port P, the springs (5) and (6) hold the main control spool (4) in its central position. In this way, a start-up jump at the actuator is prevented.
- ▶ Pilot fluid flows from bore (7) via the flow controller (8), via the control chamber (11) to the throttle gap (9), via line (10) to port Y. This connection is to be led into the tank at zero pressure.

Pressure reduction

- ▶ Build-up of the pilot pressure in the control chamber (11) as a function of the command value.
 - ▶ Pressure build-up in the spring chamber (13) via nozzle (12) and movement of the main control spool (4) to the right.
- Hydraulic fluid flows from P to A.
- ▶ The actuator pressure in port A is available in the spring chamber (14).

- ▶ Increase in the pressure in port A to the set pressure of the pilot control valve (1) leads to the movement of the main spool (4) to the left. Pressure in port A is almost identical with the set pressure at the pilot control valve (1).

Pressure limitation

- ▶ If the pressure in port A exceeds the set pressure of the pilot control valve (1), the main control spool (4) is moved further to the left.
- ▶ This opens the connection from A to T and limits the pressure pending in port A to the set command value.

Type 3DREM

For hydraulic protection against an inadmissibly high electric control current at the proportional solenoid, which imperatively results in increased pressures in port A, you can optionally install a spring-loaded pressure relief valve as maximum pressure limitation (15). The maximum pressure limitation is pre-set, referred to the relevant pressure rating (see page 6).

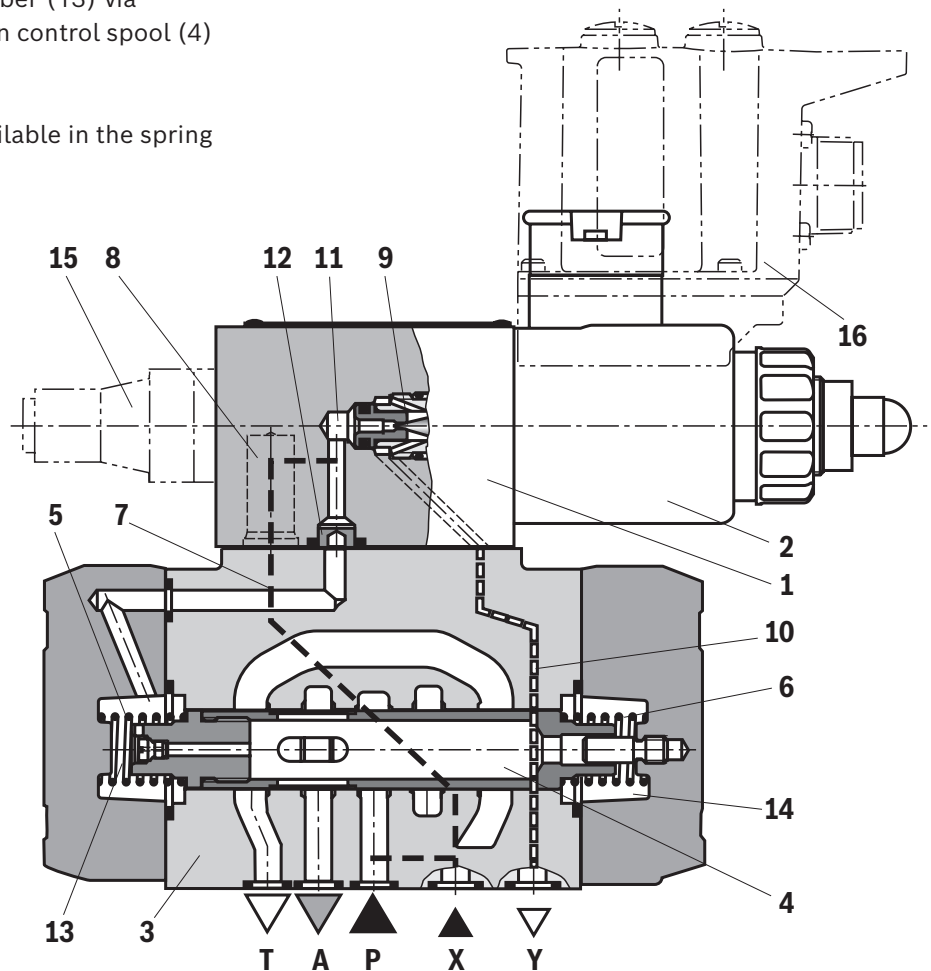

Function, section

Type HD-3DREE and HD-3DREME (with integrated electronics (OBE))

With regard to function and set-up, these valves correspond to types HD-3DRE and HD-3DREM. At the pilot control valve, there is moreover a housing (17) with the control electronics.

Supply and command value voltage are applied to the connector (18).

At the factory, the command value pressure characteristic curve is adjusted with little manufacturing tolerance.

For more information, see page 9.

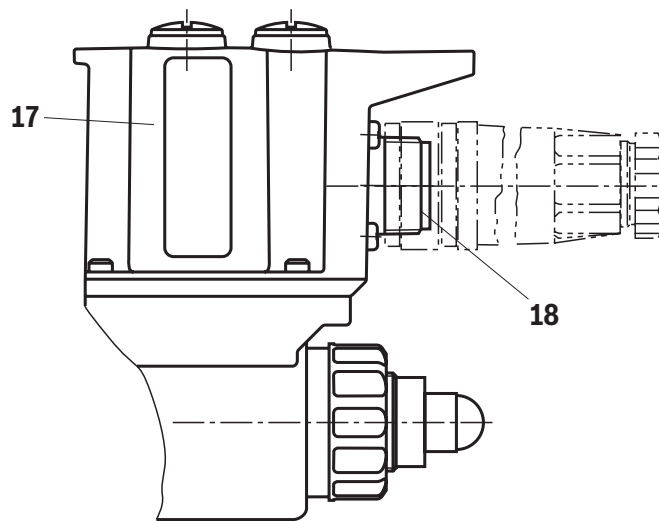

Type HD-3DRE(M)E...YG24K31

Pilot oil supply

Type HD-3DRE...XY

External pilot oil supply, external pilot oil return

The pilot oil is supplied externally from a separate pilot circuit. The pilot oil return is implemented externally via port Y into the tank.

Type HD-3DRE...Y

Internal pilot oil supply, external pilot oil return

The pilot oil supply is implemented internally from channel P of the main valve. The pilot oil return is implemented externally via port Y into the tank.

In the subplate, port X is closed.

- 1 Plug screw M6 according to DIN 906, wrench size 3 – pilot oil return
- 2 Main valve
- 3 Cover

Pilot oil supply

External: 1 closed
Internal: 1 open

Pilot oil return

external

Size 10

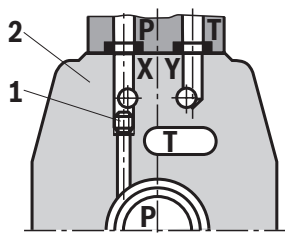

Size 16

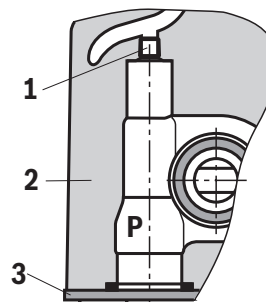

Technical data

(For applications outside these values, please consult us!)

General			
Size		NG	10 16
Weight	▶ Type 3DRE and 3DREM	kg	7.5 10.3
	▶ Type 3DREE and 3DREME	kg	7.6 10.4
Installation position	any, preferably horizontal		
Storage temperature range		°C	-20 ... +80
Ambient temperature range	▶ Type HD-3DRE and HD-3DREM	°C	-20 ... +70
	▶ Type HD-3DREE and HD-3DREME	°C	-20 ... +50
Hydraulic			
Maximum operating pressure	▶ Port P and X	bar	350 315
	▶ Port A and T	bar	315 250
	▶ Port Y	bar	separate and depressurized to the tank
Maximum set pressure in channel A	▶ Pressure rating 50 bar	bar	50 50
	▶ Pressure rating 100 bar	bar	100 100
	▶ Pressure rating 200 bar	bar	200 200
	▶ Pressure rating 250 bar	bar	- 250
	▶ Pressure rating 315 bar	bar	315 -
Minimum set pressure in channel A with flow, with command value zero		bar	< 5 < 4
Maximum pressure limitation (continuously adjustable, set at the factory)	▶ Pressure rating 50 bar	bar	70
	▶ Pressure rating 100 bar	bar	130
	▶ Pressure rating 200 bar	bar	230
	▶ Pressure rating 250 bar (size 16)	bar	270
	▶ Pressure rating 315 bar (size 10)	bar	350
Maximum flow		l/min	125 300
Pilot flow		l/min	1.1
Hydraulic fluid	see table page 7		
Hydraulic fluid temperature range		°C	-20 ... +80
Viscosity range		mm ² /s	15 ... 380
Maximum admissible degree of contamination of the hydraulic fluid; cleanliness class according to ISO 4406 (c)	class 20/18/15 ¹⁾		
Hysteresis		%	±3 ²⁾
Repetition accuracy		%	< ±2 ²⁾
Linearity		%	±3.5 ²⁾
Manufacturing tolerance of the command value pressure characteristic curve, related to the hysteresis characteristic curve; pressure increasing	▶ Type HD-3DRE(M)	%	< ±1.5 ^{2; 4)}
	▶ Type HD-3DRE(M)E		< ±1.5 ^{2; 4)}
	▶ Type HD-3DRE(M)	%	< ±5 ^{2; 5)}
	▶ Type HD-3DRE(M)E	%	< ±5 ^{2; 5)}
Step response $T_u + T_g$	Command value 10 % → 90 %	ms	< 140 ⁶⁾

1)The cleanliness classes specified for the components must be adhered to in hydraulic systems. Effective filtration prevents faults and simultaneously increases the life cycle of the components.

2)Of the maximum set pressure

3)Comparison at the factory

4) At 20 % of the command value

5) At 100 % of the command value

6)Measured with standing hydraulic fluid column, 1.0 liter at port A

Technical data

(For applications outside these values, please consult us!)

Hydraulic fluid	Classification	Suitable sealing materials	Standards
Mineral oils	HL, HLP, HLPD, HVLP, HVLPD	NBR, FKM	DIN 51524
Bio-degradable	▶ Insoluble in water	HETG	ISO 15380
		HEES	
	▶ Soluble in water	HEPG	ISO 15380
Flame-resistant	▶ Water-free	HFDU (glycol base)	ISO 12922
		HFDU (ester base)	
		HFDR	
	▶ Containing water	HFC (Fuchs: Hydrotherm 46M, Renosafe 500; Petrofer: Ultra Safe 620; Houghton: Safe 620; Union: Carbide HP5046)	NBR



Important information on hydraulic fluids:

- ▶ For further information and data on the use of other hydraulic fluids, please refer to the data sheets above or contact us.
- ▶ There may be limitations regarding the technical valve data (temperature, pressure range, life cycle, maintenance intervals, etc.).
- ▶ The ignition temperature of the hydraulic fluid used must be 50 K higher than the maximum surface temperature.
- ▶ **Bio-degradable and flame-resistant – containing water:** If components with galvanic zinc coating (e.g. version "J3" or "J5") or parts containing zinc are used, small amounts of dissolved zinc may get into the hydraulic system and cause accelerated aging of the hydraulic fluid. Zinc soap may form as a chemical reaction product, which may clog filters, nozzles and solenoid valves – particularly in connection with local heat input.

▶ Flame-resistant – containing water:

- Due to increased cavitation tendency with HFC hydraulic fluids, the life cycle of the component may be reduced by up to 30 % as compared to the use with mineral oil HLP. In order to reduce the cavitation effect, it is recommended – if possible specific to the installation – to back up the return flow pressure in ports T to approx. 20 % of the pressure differential at the component.
- Dependent on the hydraulic fluid used, the maximum environment and hydraulic fluid temperature must not exceed 50 °C. In order to reduce the heat input into the component, the command value profile is to be adjusted for proportional and high-response valves.

Electric			
Version		"G24"	"G24-8"
Minimum solenoid current	mA	≤ 100	≤ 100
Maximum solenoid current	mA	1600 ±10 %	800 ±5 %
Solenoid coil resistance	▶ Cold value at 20 °C	Ω	20.6
	▶ Maximum hot value	Ω	33
Duty cycle	%	100	100

Electrical, integrated electronics (OBE)			
Supply voltage	▶ Nominal voltage	VDC	24
	▶ Lower limit value	VDC	21
	▶ Upper limit value	VDC	35
Current consumption		A	≤ 1.5
Fuse protection		A	2 (time-lag)
Inputs	▶ Voltage	V	0 ... 10
	▶ Current	mA	4 ... 20
Output	▶ Actual current value	mV / mA	1
Protection class of the valve according to EN 60529			IP65 (with correctly installed electrical connection)

Electrical connections and assignment

► Type 3DRE and 3DREM

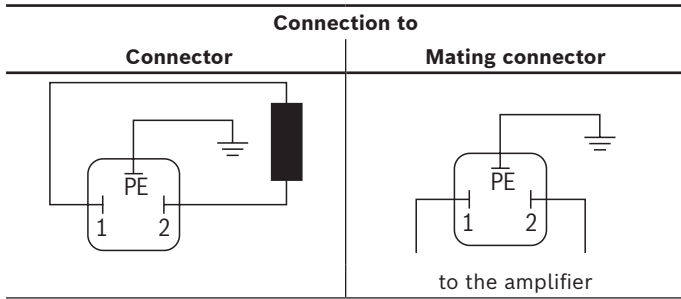

► Type 3DREE and 3DREME

Connector pin assignment	Contact	Interface assignment	
		"A1"	"F1"
Supply voltage	A	24 VDC ($u(t) = 21 \text{ V} \dots 35 \text{ V}$); $I_{\max} \leq 1.5 \text{ A}$	
	B	0 V	
Reference potential actual value	C	reference contact F; 0 V	reference contact F; 0 V
Differential amplifier input	D	0 ... 10 V; $R_E = 100 \text{ k}\Omega$	4 ... 20 mA; $R_E = 100 \Omega$
	E	reference potential command value	
Measuring output (actual value)	F	0 ... 1.6 V actual value ($1 \text{ mV} \triangleq 1 \text{ mA}$) load resistance > 10 k Ω	
Protective ground	PE	functional ground (directly connected to the valve housing)	

Connection cable for type 3DRE(M)E

- Recommendation 6-wire, 0.75 or 1 mm² plus protective grounding conductor and screening
- Only connect the screening to PE on the supply side
- Maximum admissible length = 100 m

The minimum supply voltage at the power supply unit depends on the length of the supply line (see diagram).

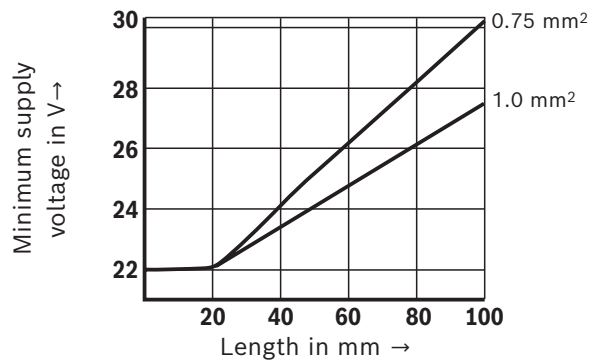

Block diagram: Integrated electronics (OBE)

Function

The electronics are supplied with voltage via ports A and B. The command value is applied to the differential amplifier ports D and E.

Via the characteristic curve generator, the command value solenoid current characteristic curve is adjusted to the valve so that non-linearities in the hydraulics are compensated for and a linear command value pressure characteristic curve is created.

The current controller controls the solenoid current independently of the solenoid coil resistance.

The power stage of the electronics for controlling the proportional solenoid is a chopper amplifier with a clock frequency of approx. 180 Hz to 400 Hz. The output signal is pulse-width modulated (PWM).

For checking the solenoid current, a voltage can be measured at the connector between pin F(+) and pin C(-) that is proportional to the solenoid current. 1 mV corresponds to 1 mA solenoid current.

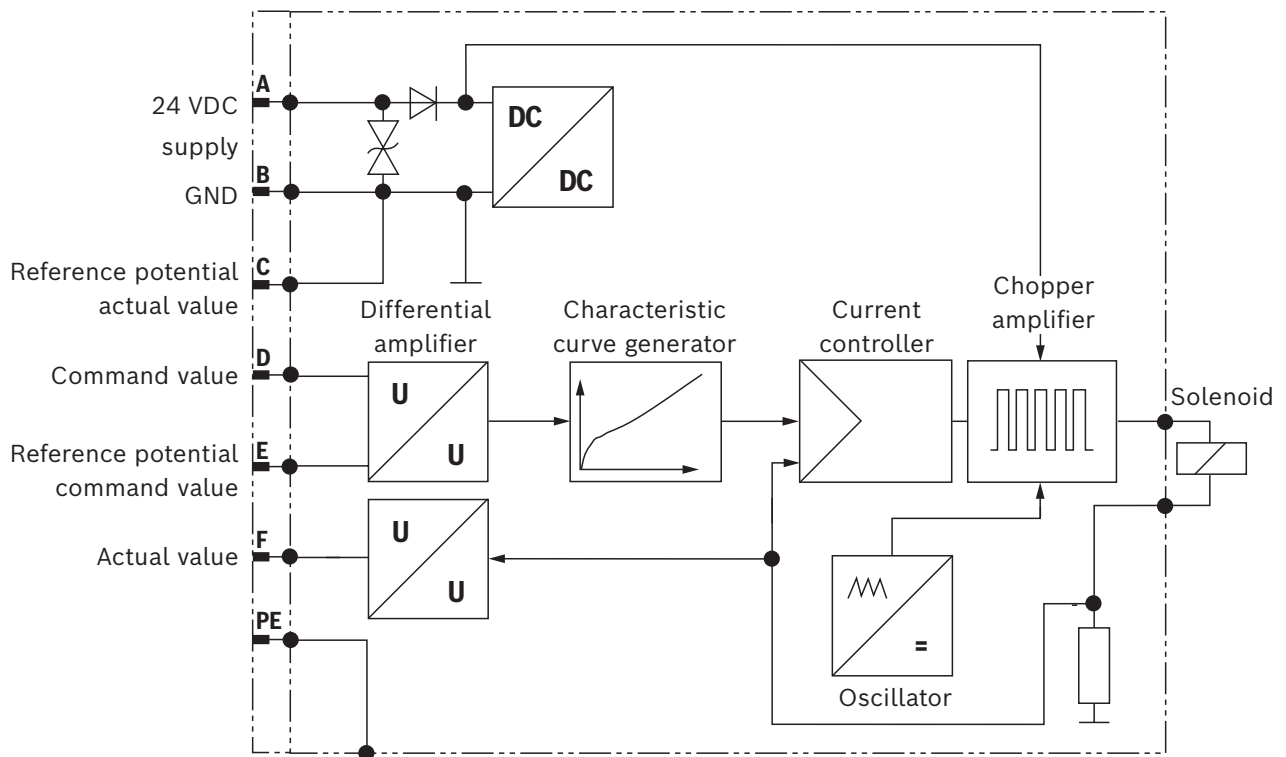

Characteristic curves

(measured with HLP46, $\vartheta_{oil} = 40 \pm 5 \text{ }^\circ\text{C}$)

Pressure in port A depending on the command value (manufacturing tolerance) – Without flow

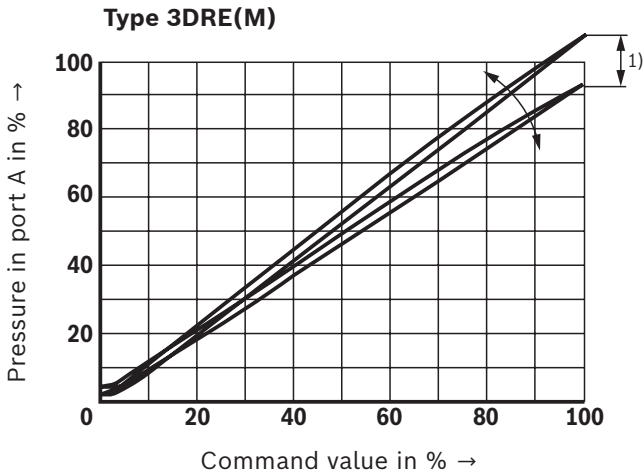

1) In order to be able to adjust several valves to the same characteristic curve, the manufacturing tolerance can - with version 3DRE(M) - be changed at the external amplifier (see page 18) using the command value attenuator "G". In this connection, do not set the pressure higher than the maximum set pressure of the pressure rating with command value 100 %.

Pressure in port P depending on the command value

Comparison "G24" and "G24-8", pressure rating 200 bar
(with amplifier HD-VT-VSPA1-1-1X, 800 mA coil)

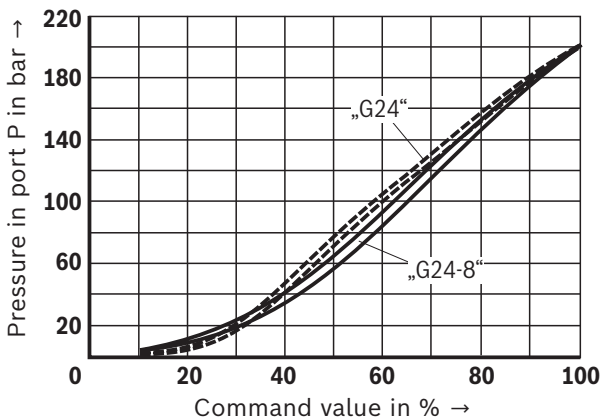

Current drop with version "G24-8"

(increasing ambient temperature, 24 V, 100 % duty cycle)

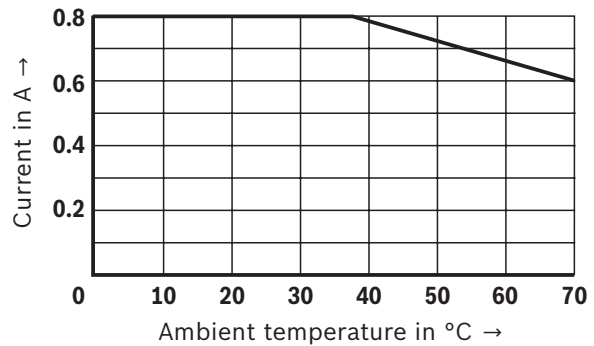

Characteristic curves: Size 10
 (measured with HLP46, $\vartheta_{oil} = 40 \pm 5 \text{ } ^\circ\text{C}$)

Pressure in port A depending on the command value – flow 0 l/min

Pressure rating 50 bar

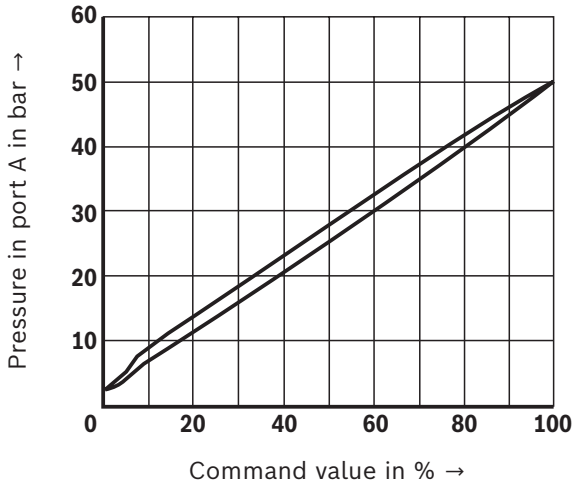

Pressure rating 100 bar

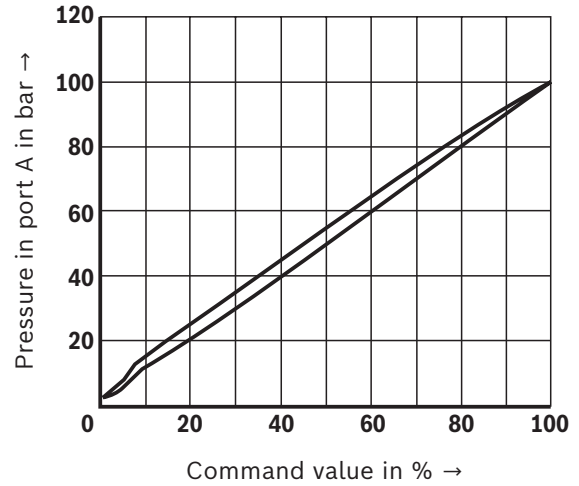

Pressure rating 200 bar

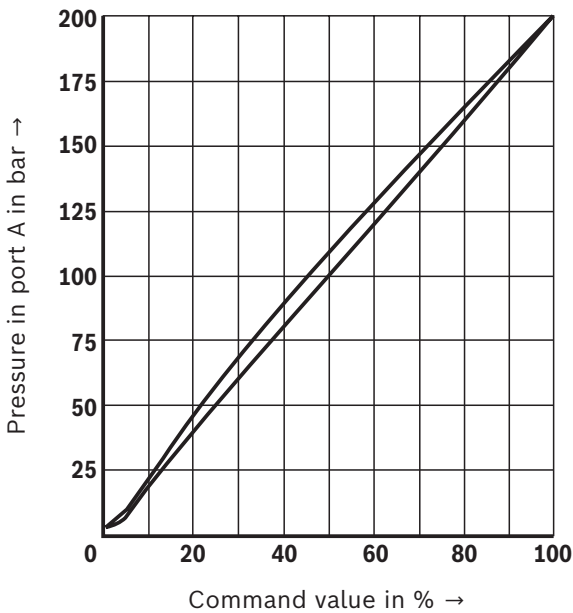

Pressure rating 315 bar

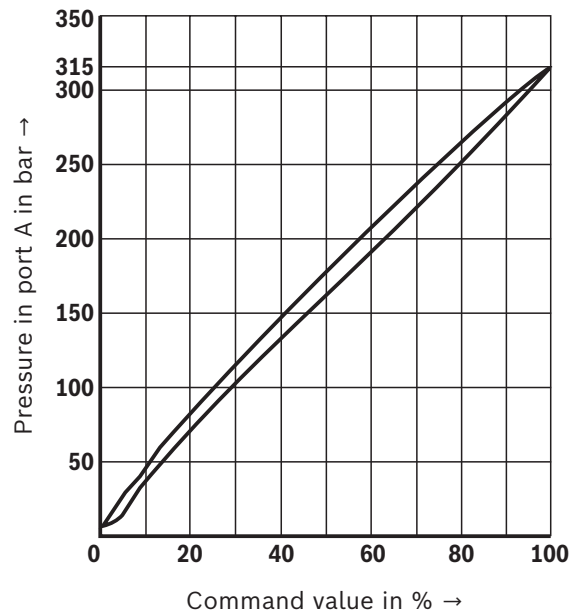

Notice:

Valve body and hydraulic fluid temperature-compensated.
 Large temperature differences may lead to differing characteristic curves/values.

Characteristic curves: Size 10
(measured with HLP46, $\vartheta_{oil} = 40 \pm 5 \text{ }^\circ\text{C}$)

Δp - q_V characteristic curves

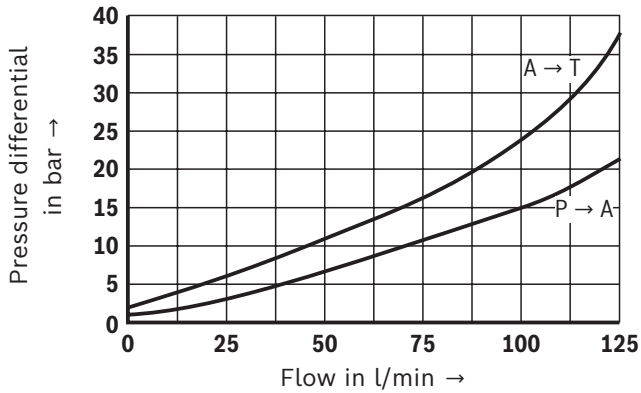

Pressure in port A depending on the flow

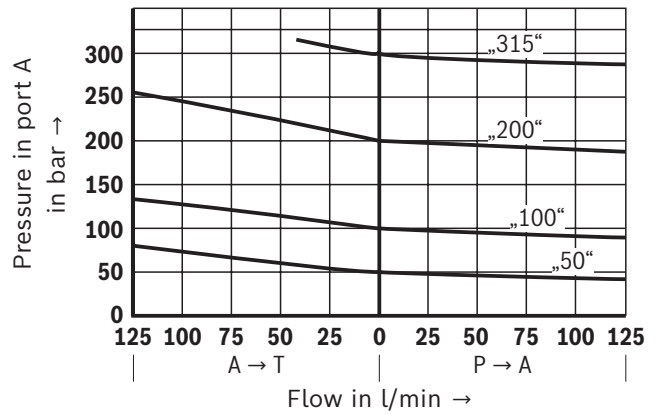

Minimum set pressure depending on the flow
(command value zero)

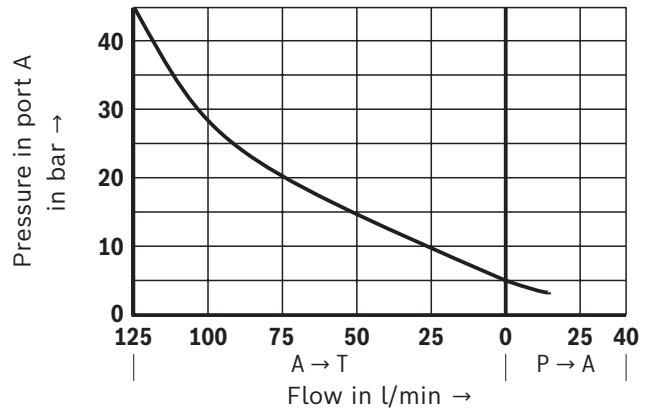

Notice:

Valve body and hydraulic fluid temperature-compensated.
Large temperature differences may lead to differing characteristic curves/values.

Characteristic curves: Size 16
(measured with HLP46, $\vartheta_{oil} = 40 \pm 5 \text{ } ^\circ\text{C}$)

Pressure in port A depending on the command value – flow 0 l/min

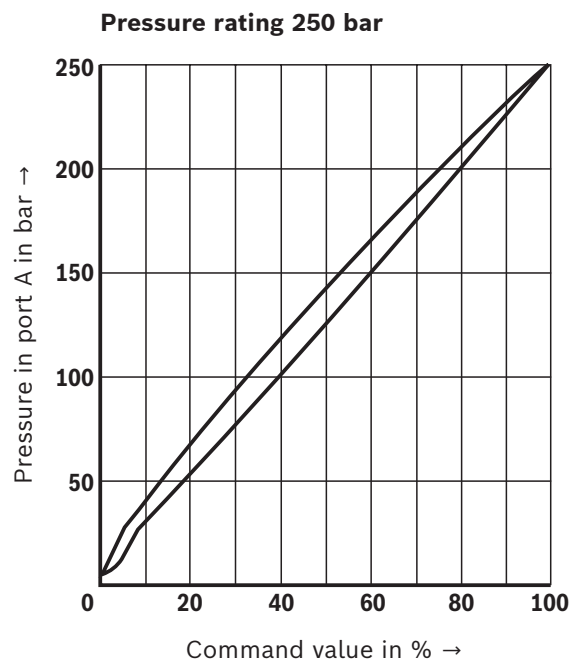
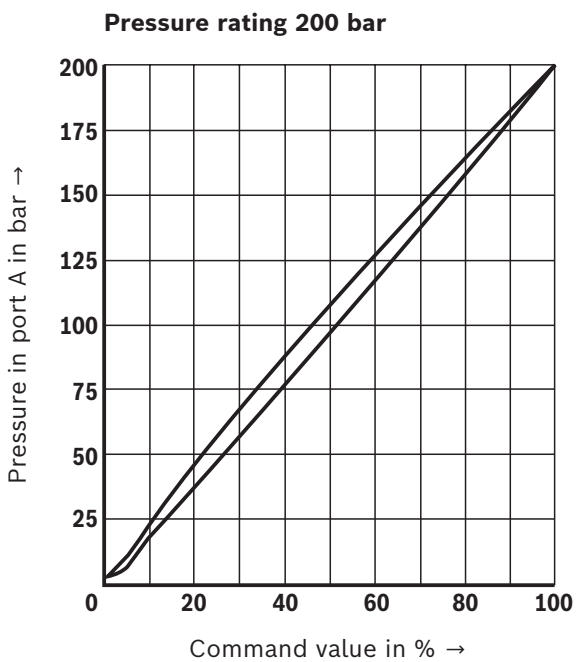
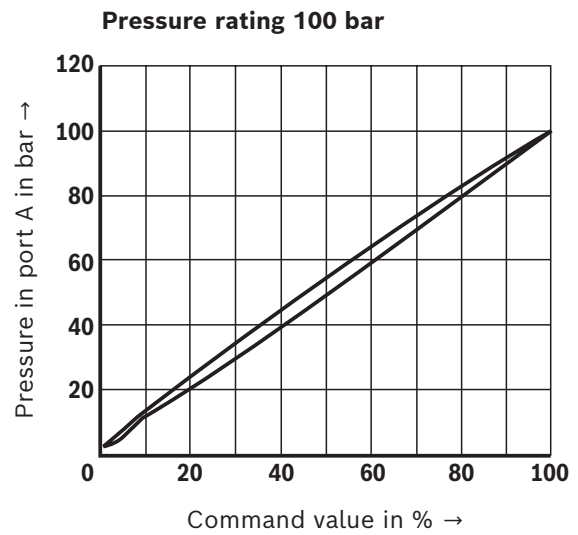
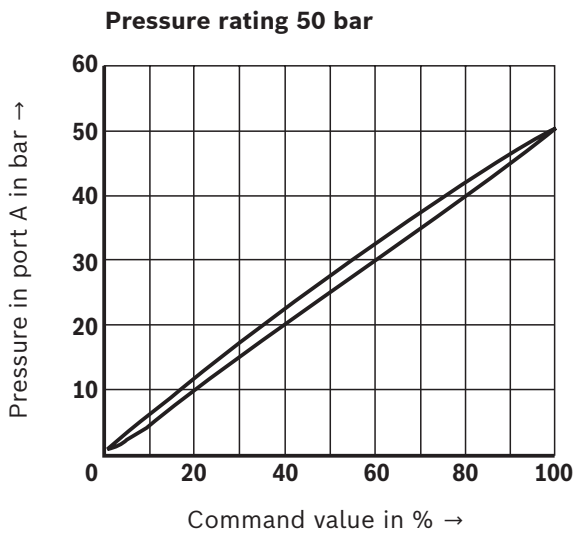

Notice:

Valve body and hydraulic fluid temperature-compensated.
Large temperature differences may lead to differing characteristic curves/values.

Characteristic curves: Size 16
 (measured with HLP46, $\vartheta_{oil} = 40 \pm 5 \text{ }^\circ\text{C}$)

Δp - q_V characteristic curves

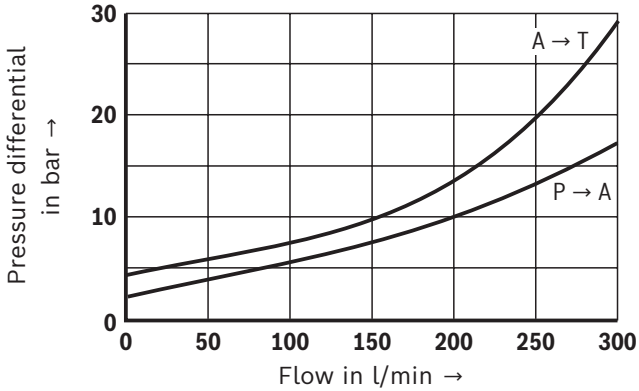

Pressure in port A depending on the flow

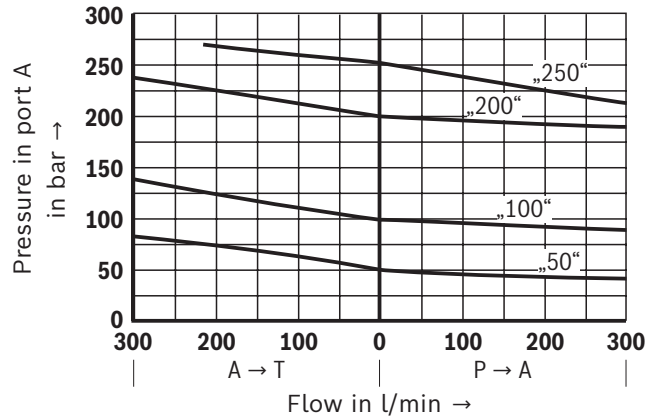

Minimum set pressure depending on the flow
 (command value zero)

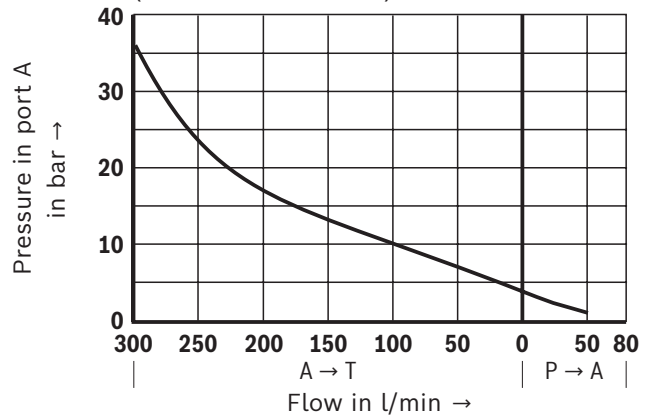

Notice:

Valve body and hydraulic fluid temperature-compensated.
 Large temperature differences may lead to differing characteristic curves/values.

Dimensions: Size 10
(dimensions in mm)

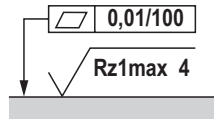
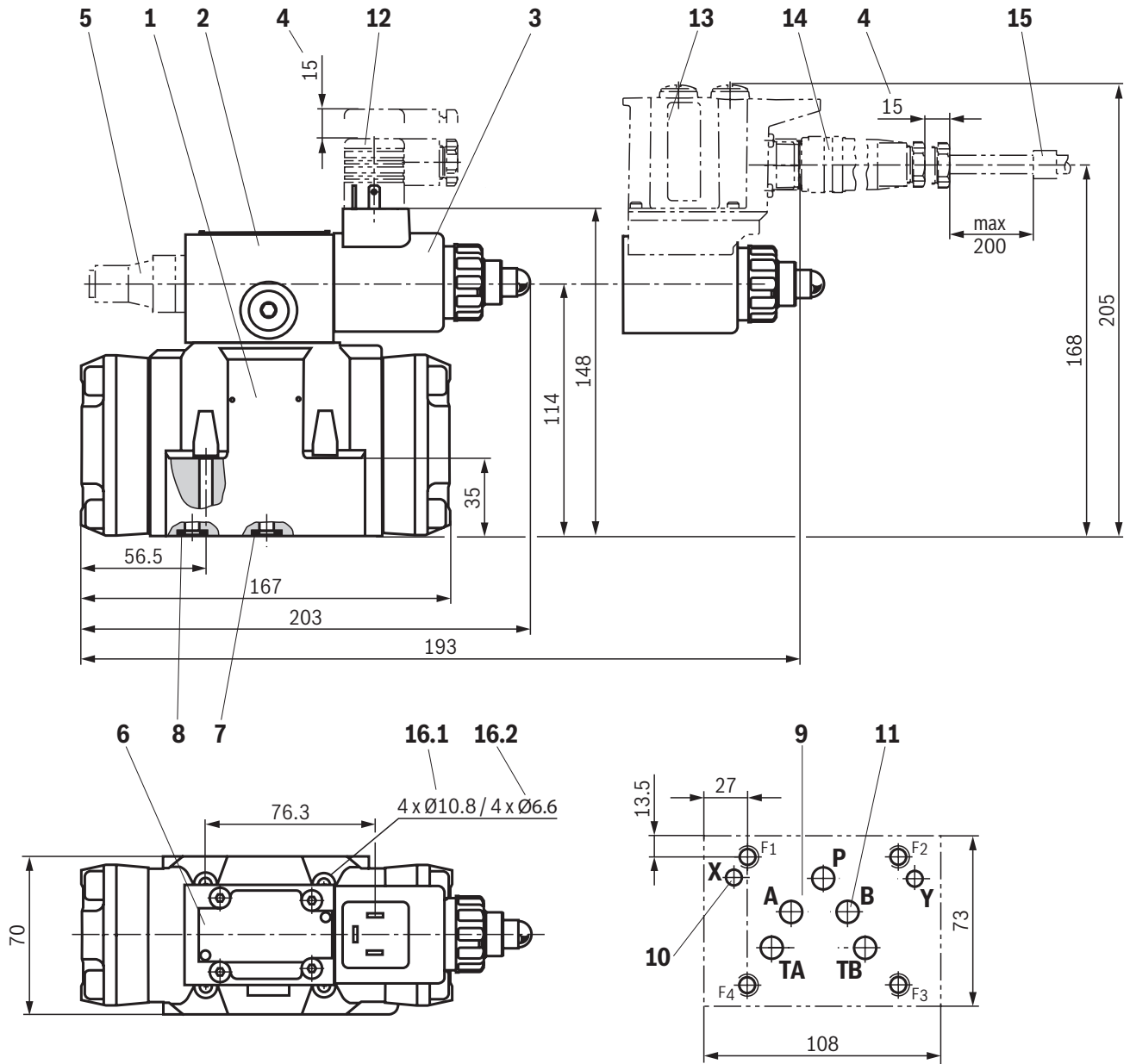

Required surface quality of the valve contact surface

Dimensions: Size 16
(dimensions in mm)

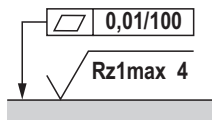
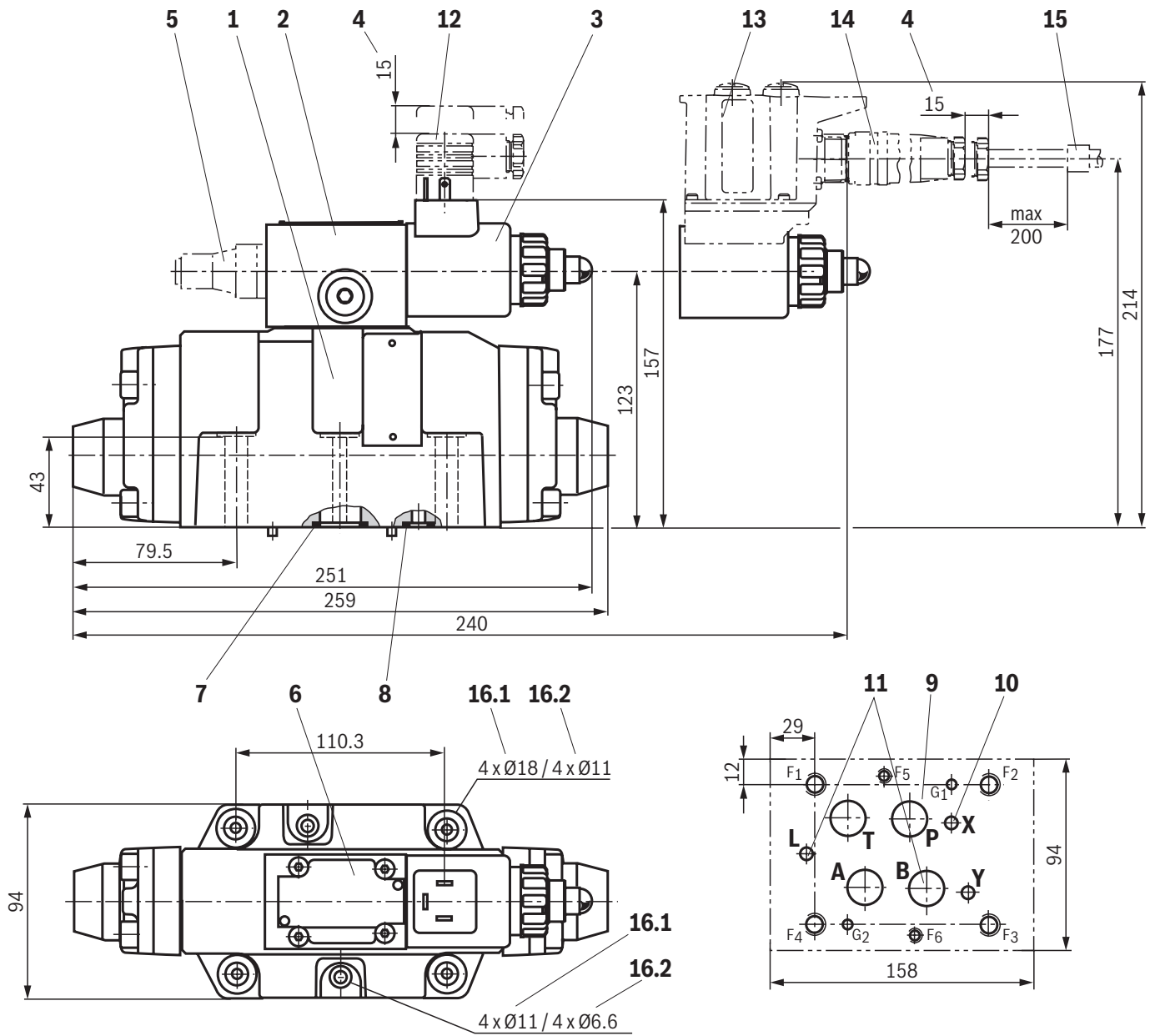

Required surface quality of the
valve contact surface

Dimensions

- 1 Main valve
- 2 Pilot valve
- 3 Proportional solenoid
- 4 Space required to remove the mating connector
- 5 Maximum pressure limitation (type 3DREM...)
- 6 Name plate
- 7 Identical seal rings for port A, B, P, TA and TB
- 8 Identical seal rings for ports X and Y
- 9 Machined valve contact surface; porting pattern according to ISO 4401-05-05-0-05
- 10 With "internal" pilot oil supply (version "Y"), port X in the subplate must be closed.
- 11 Port B must be closed in the subplate
- 12 Mating connector for type 3DRE(M) (separate order, see page 18)
- 13 Integrated electronics (type 3DREE, 3DREME) with connector
- 14 Mating connector for type 3DRE(M)E, plastic or metal version (separate order, see page 18)
- 15 Cable fastening
- 16.1 Recess
- 16.2 Bore

Valve mounting screws (separate order)

Size	Quantity	Hexagon socket head cap screws
10	4	ISO 4762 - M6 x 45 - 10.9 Friction coefficient $\mu_{total} = 0.09 \dots 0.14$; tightening torque $M_A = 12.5 \text{ Nm} \pm 10 \%$
	or	
16	4	ISO 4762 - M6 x 45 - 10.9 Friction coefficient $\mu_{total} = 0.12 \dots 0.17$; tightening torque $M_A = 15.5 \text{ Nm} \pm 10 \%$
	2	ISO 4762 - M6 x 60 - 10.9 Friction coefficient $\mu_{total} = 0.09 \dots 0.14$; tightening torque $M_A = 12.2 \text{ Nm} \pm 10 \%$
	4	ISO 4762 - M10 x 60 - 10.9 Friction coefficient $\mu_{total} = 0.09 \dots 0.14$; tightening torque $M_A = 59 \text{ Nm} \pm 20 \%$
	or	
	2	ISO 4762 - M6 x 60 - 10.9 Friction coefficient $\mu_{total} = 0.12 \dots 0.17$; tightening torque $M_A = 15.5 \text{ Nm} \pm 10 \%$
	4	ISO 4762 - M10 x 60 - 10.9 Friction coefficient $\mu_{total} = 0.12 \dots 0.17$; tightening torque $M_A = 75 \text{ Nm} \pm 10 \%$

 **Notice:**

- ▶ For reasons of stability, exclusively these valve mounting screws may be used.
- ▶ The tightening torque of the hexagon socket head cap screws refers to the maximum operating pressure.

Subplates (separate order) with porting pattern according to ISO 4401

Accessories (separate order)**Mating connectors and cable sets**

Item 1)	Designation	Version
12	Mating connector; for valves with round connector, 6-pole + PE	straight, metal
		straight, plastic
14	Mating connector; for valves with "K4" connector, 2-pole + PE, design A	without circuitry, M16 x 1.5, 12 ... 240 V, "b"

1) See dimensions on page 15 and 16.

External control electronics**Designation**

Valve amplifier for proportional valves without electrical position feedback; type HD-VT-VSPA1-1